

P16=P17=P19=P20

P6=P7

RELACAO DO ACO

S16=S17=S19=S20

S3=S7

S18

ACO	N	DIAM (mm)	QUANT	CUNTA	CUNTA	C.TOTAL (kg)
CA60	1	4,2	104	105	105	1133,6
CA60	2	4,2	40	40	40	1130,4
CA60	3	4,2	40	40	40	3492,0
CA60	4	4,2	72	72	72	3090,0
CA60	5	8,0	103	103	103	558,0
CA60	6	8,0	83	83	83	448,4
CA60	7	8,0	95	95	95	518,0
CA60	8	8,0	95	95	95	518,0
CA60	9	8,0	25	25	25	142,2
CA60	10	8,0	19	19	19	102,6
CA60	11	8,0	19	19	19	102,6
CA60	12	8,0	143	143	143	787,4
CA60	13	8,0	103	103	103	567,4
CA60	14	8,0	19	19	19	102,6
CA60	15	8,0	19	19	19	102,6
CA60	16	10,0	24	24	24	150,0
CA60	17	10,0	40	40	40	231,6
CA60	18	10,0	40	40	40	231,6

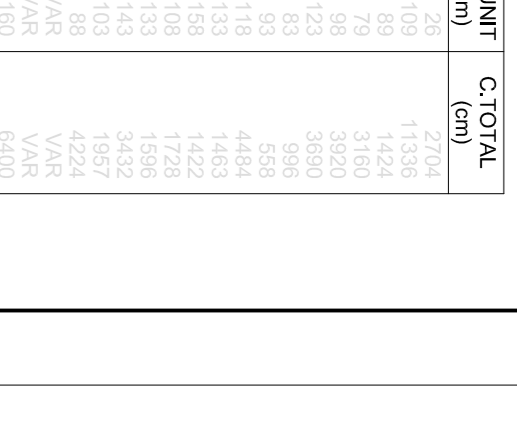
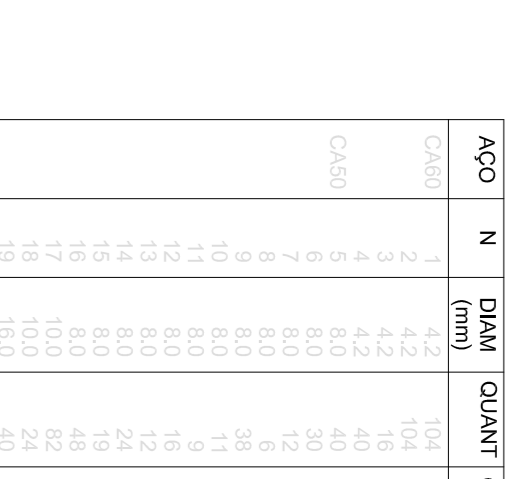
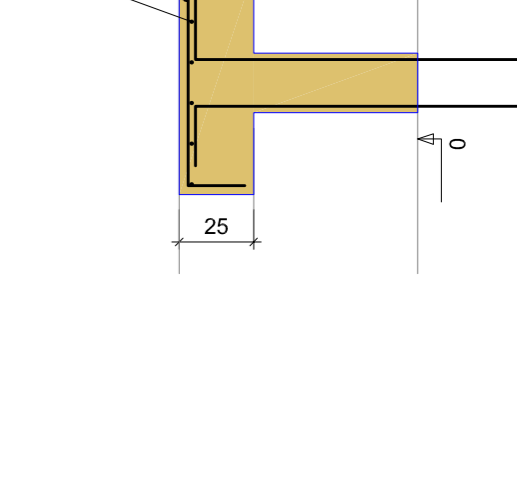
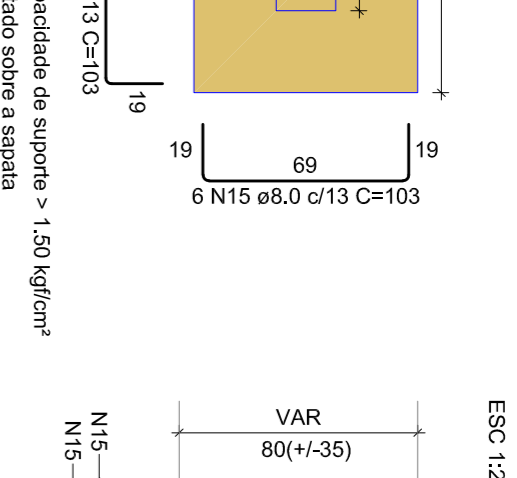
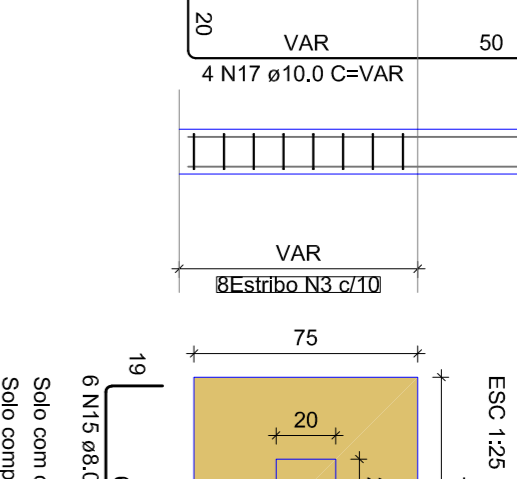
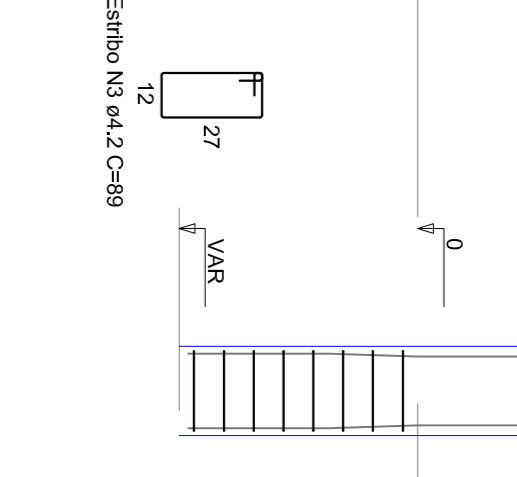
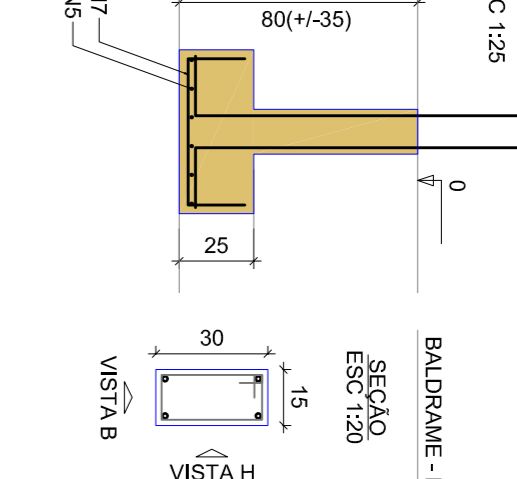
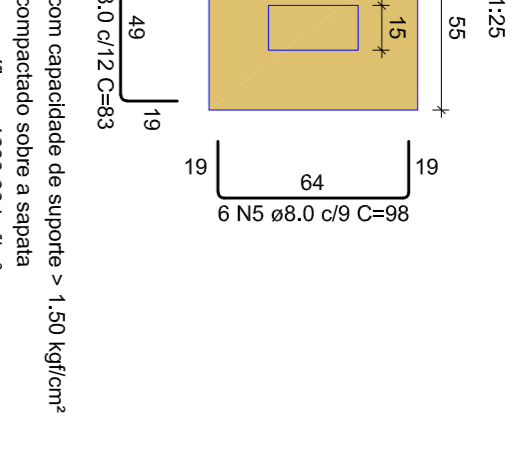
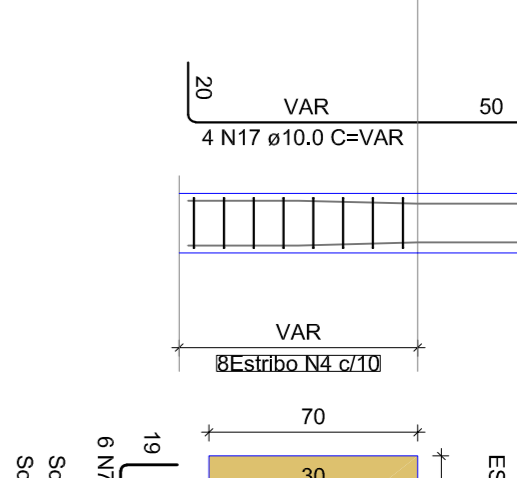
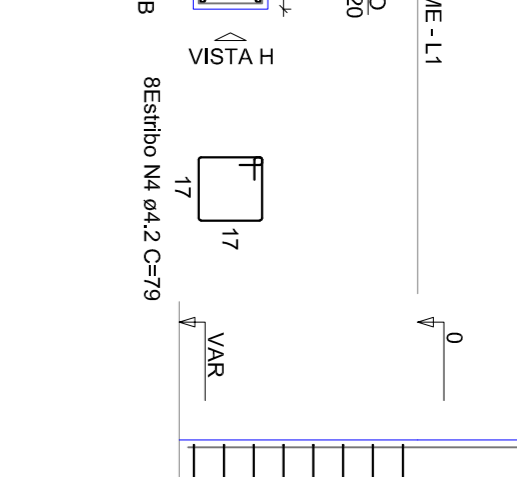
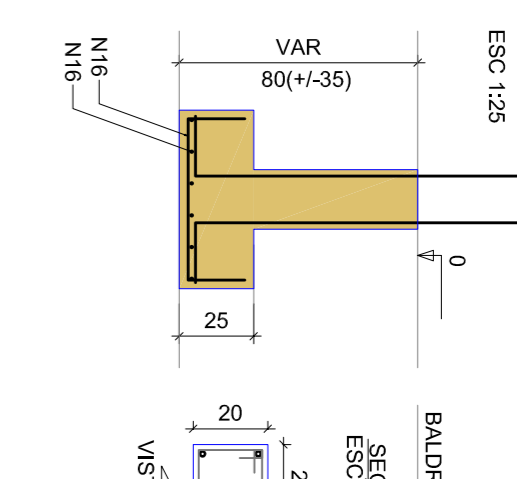
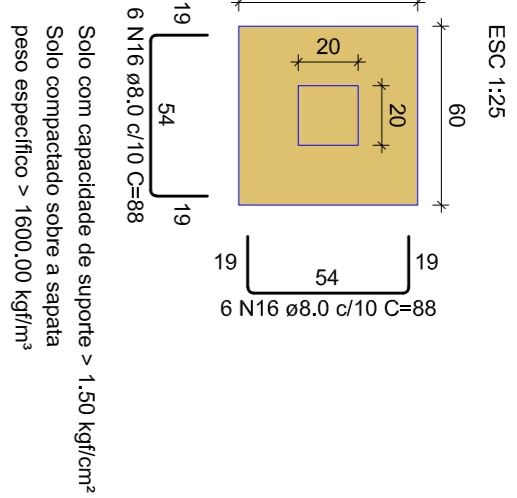

P1=P5=P8=P10

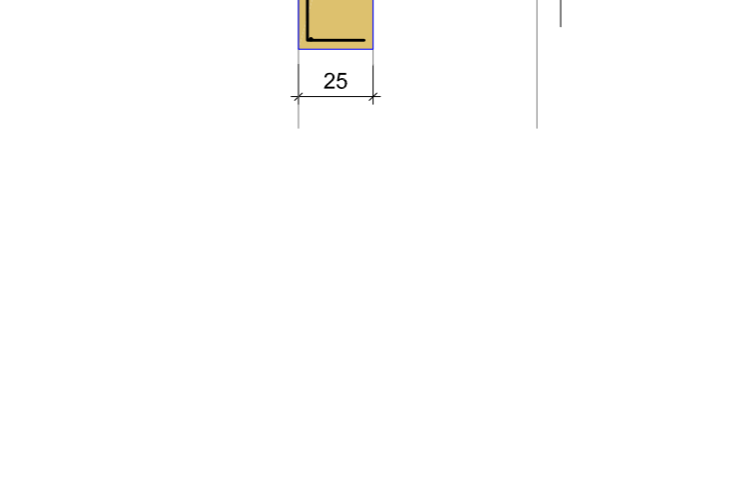
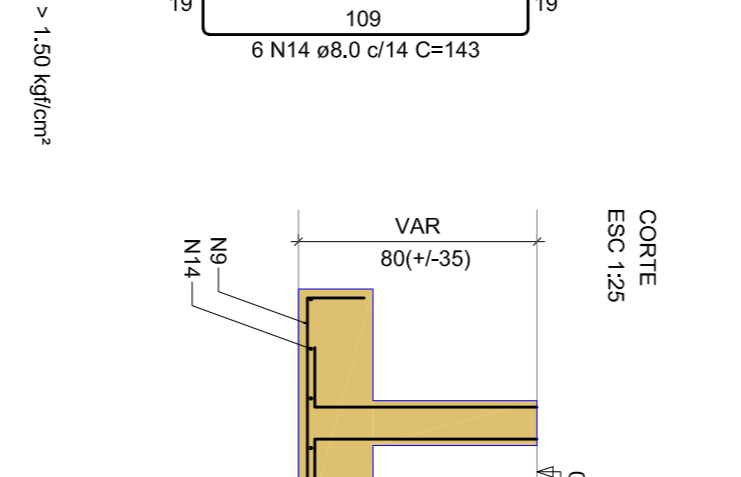
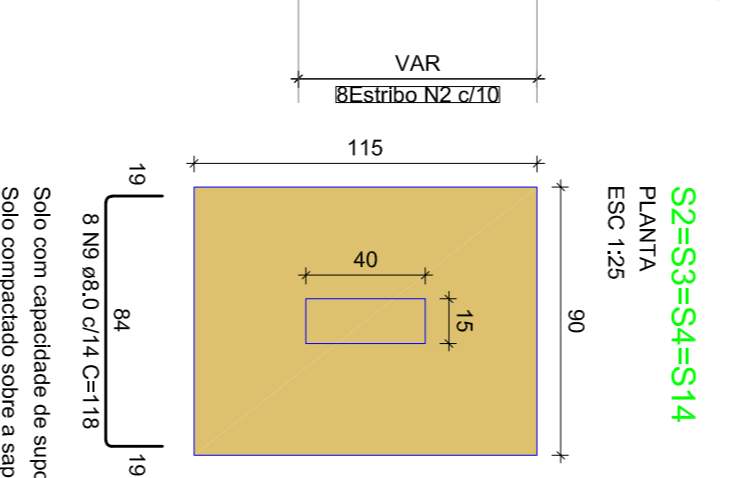
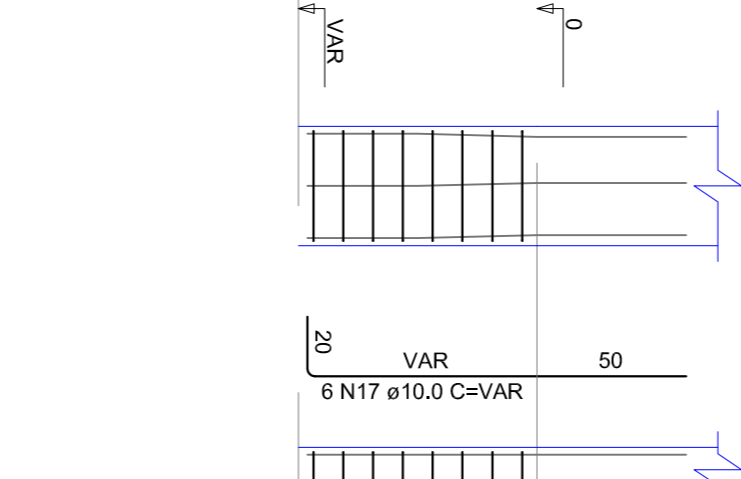
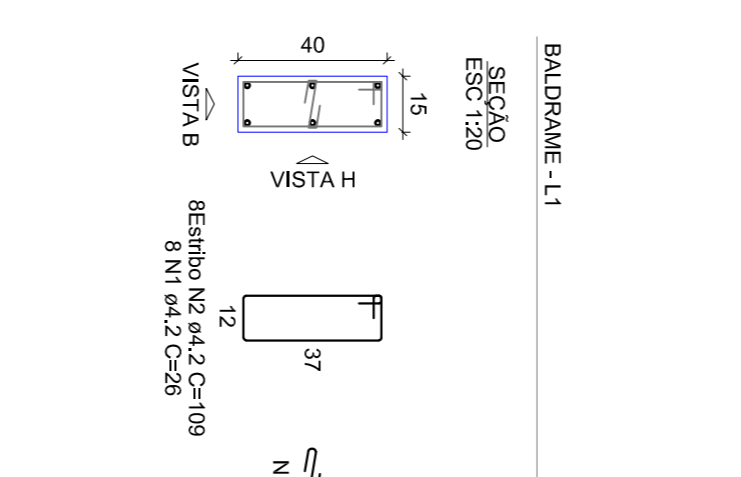
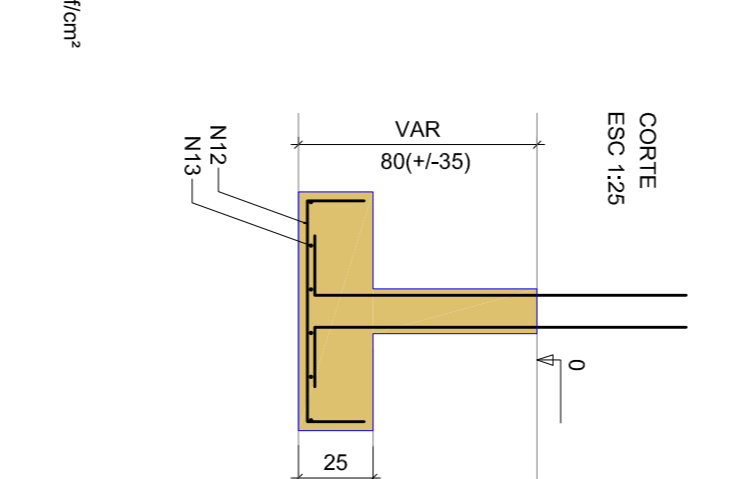
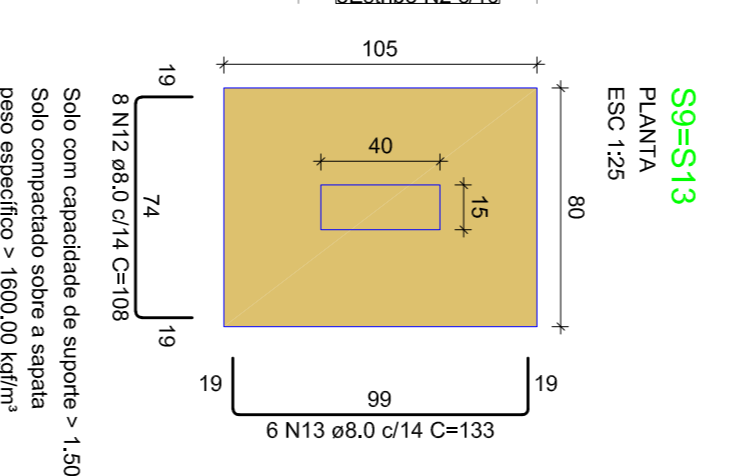
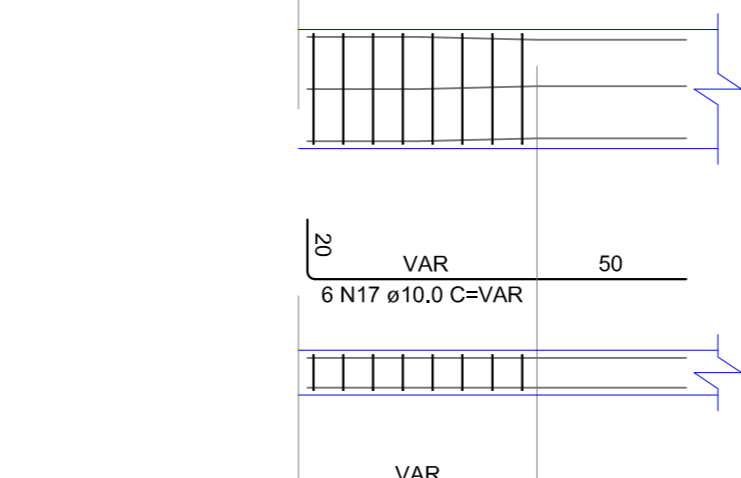
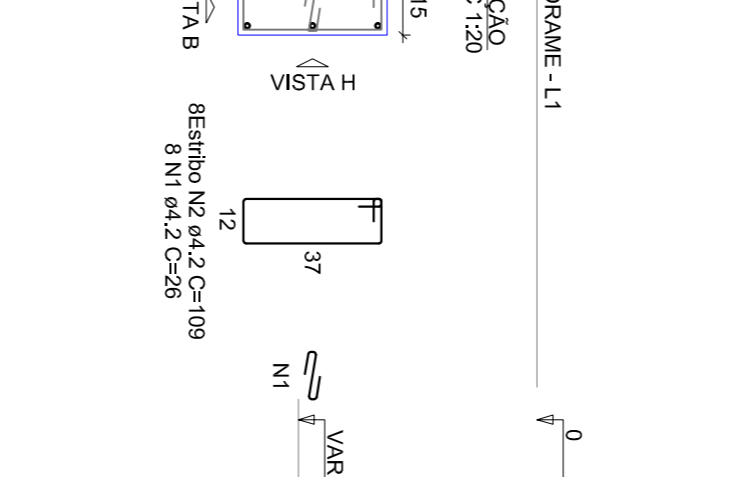
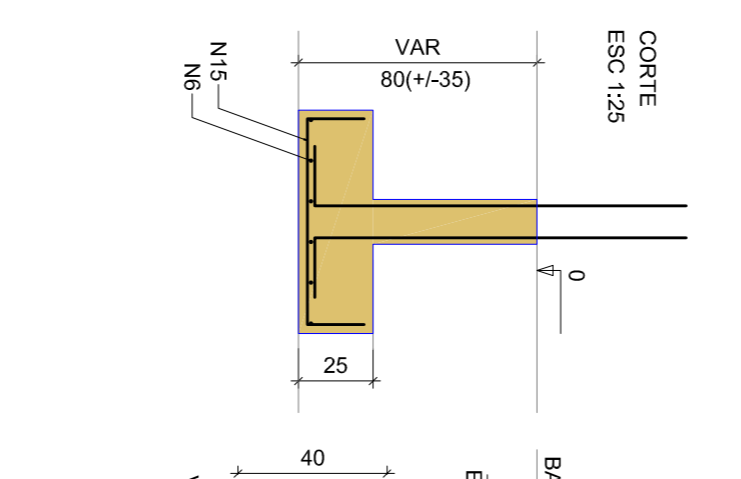
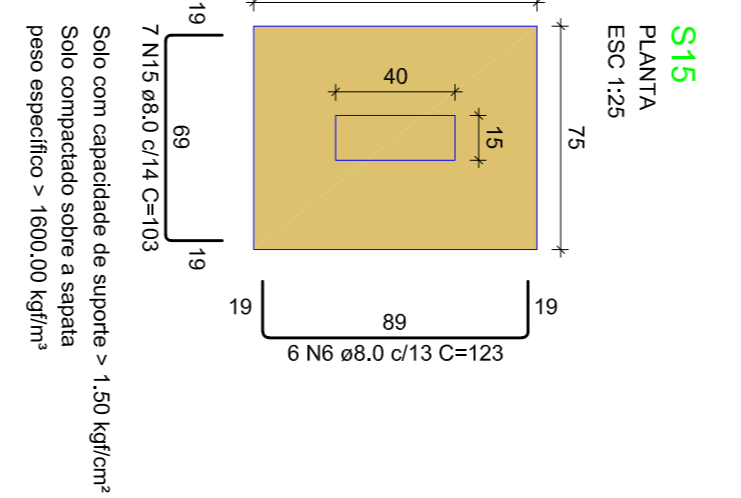
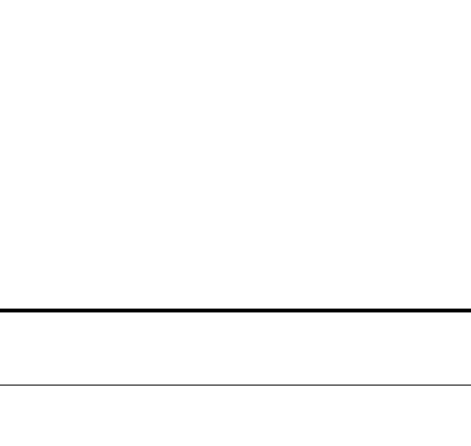
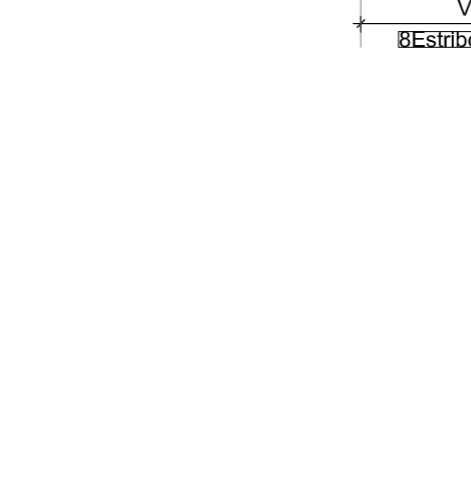
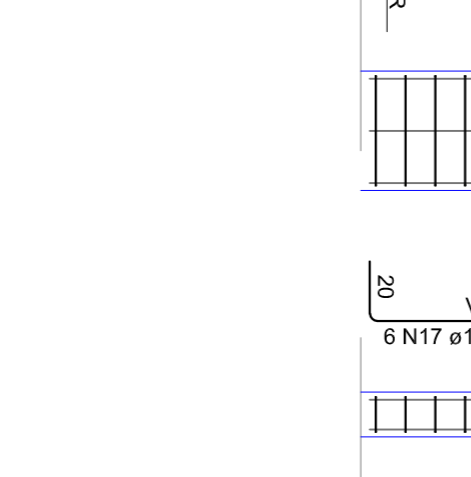
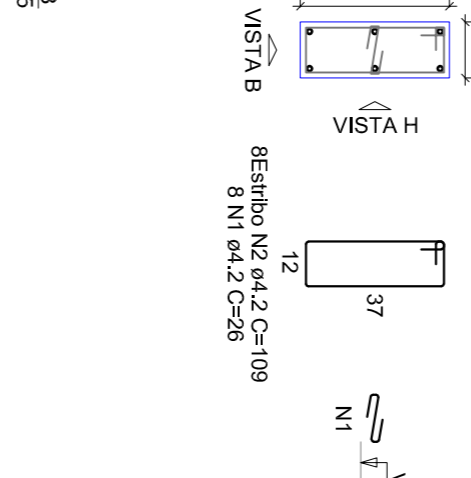
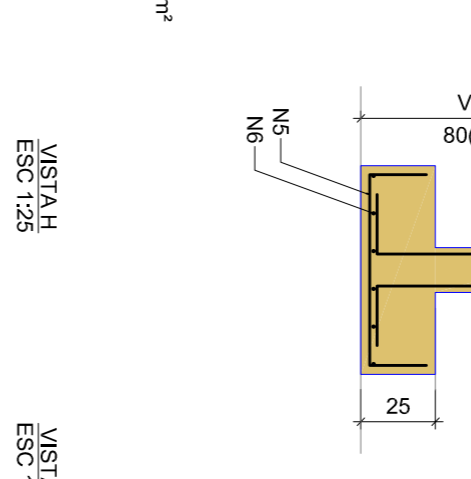
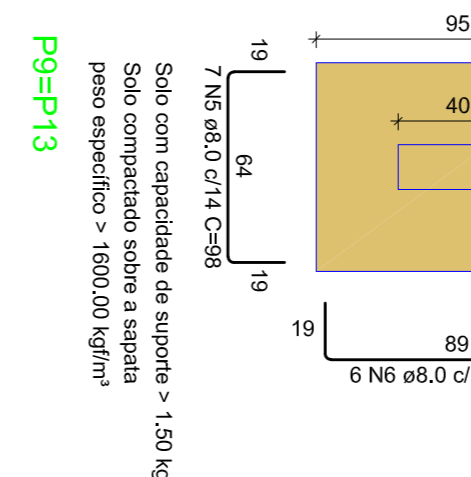
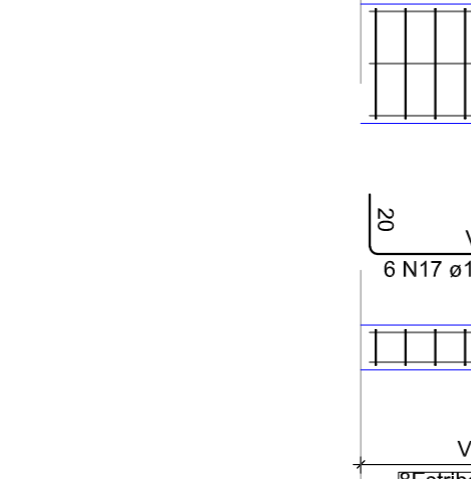
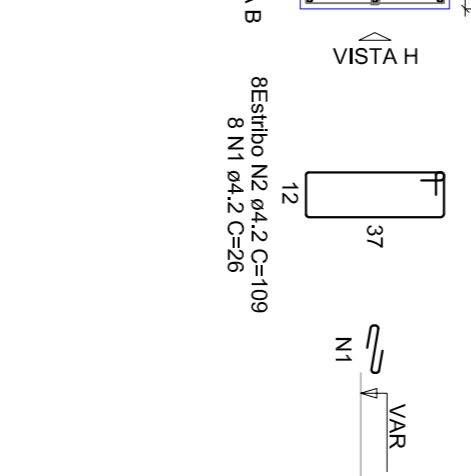
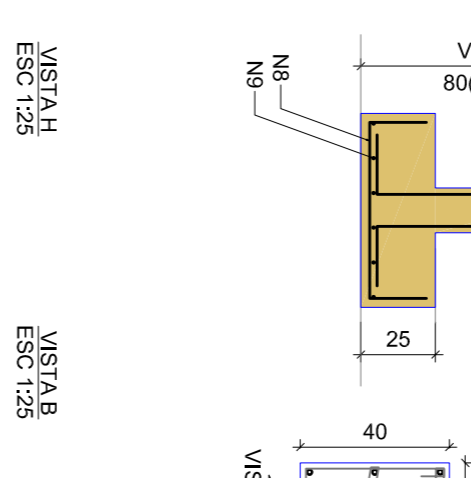
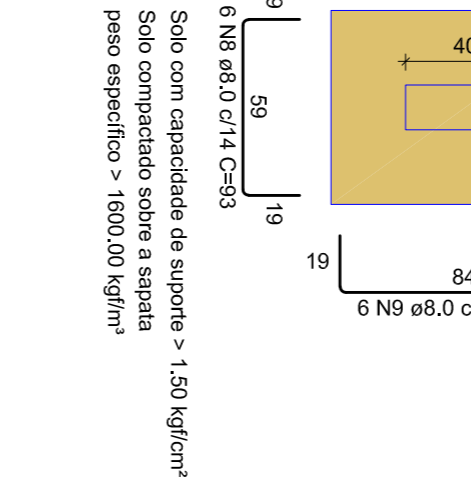
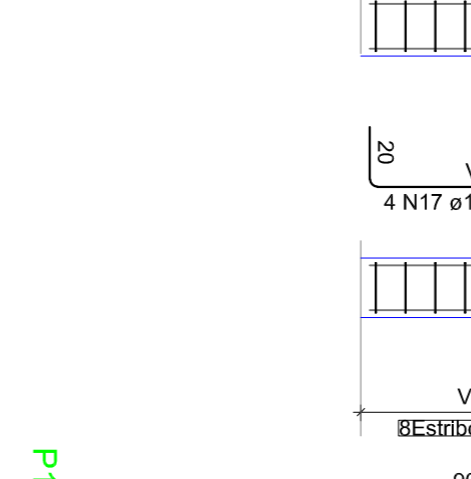
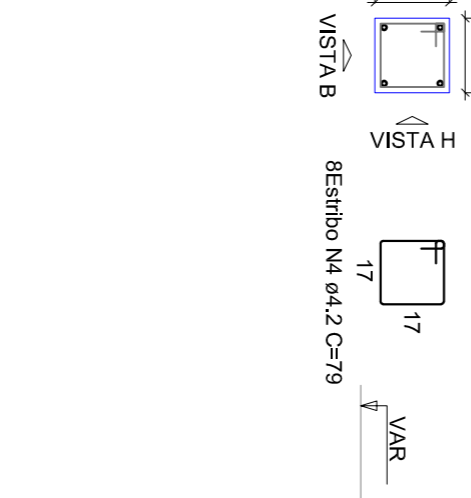
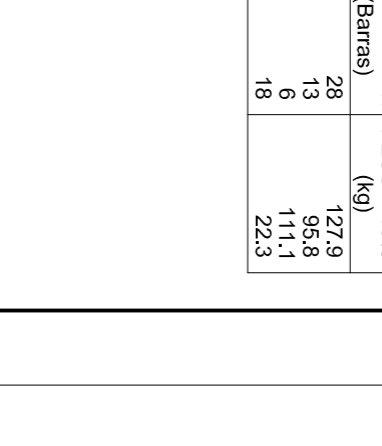
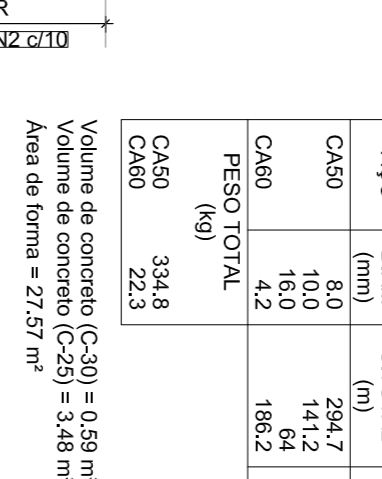
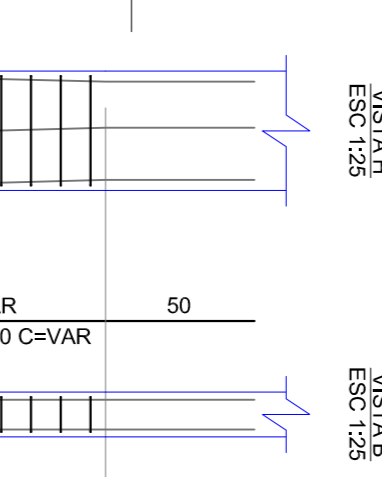
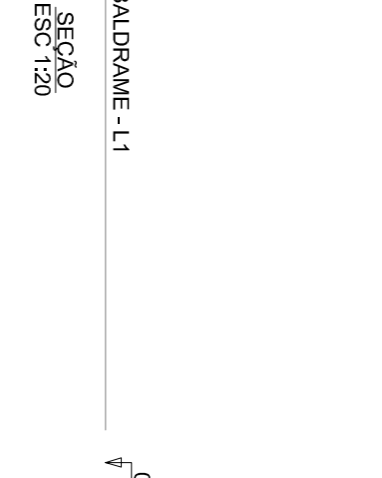
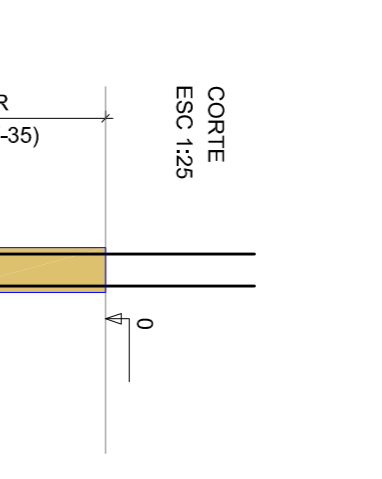
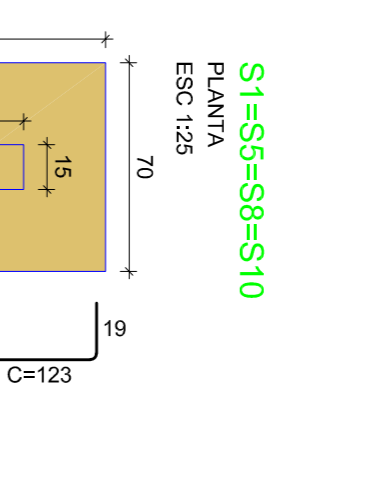
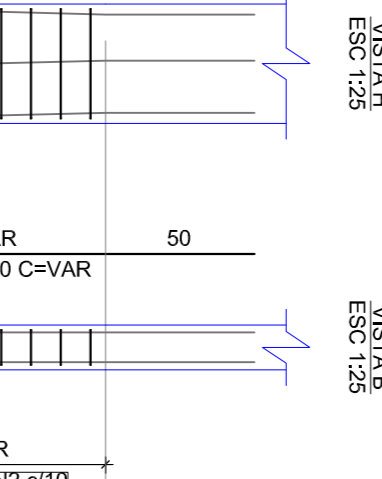
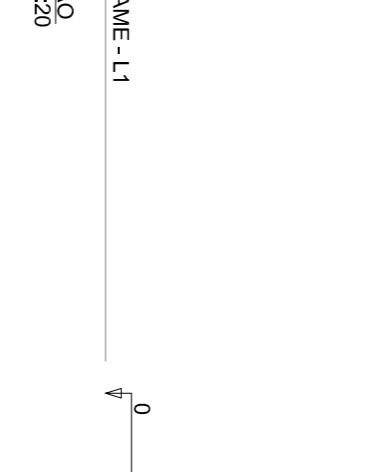
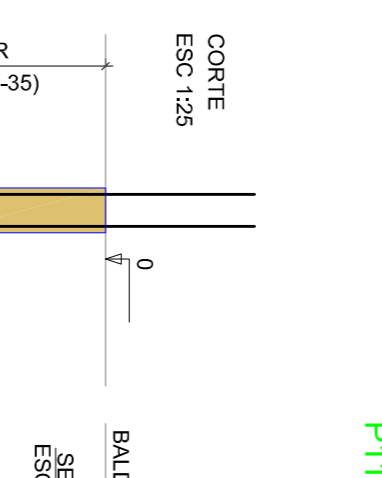
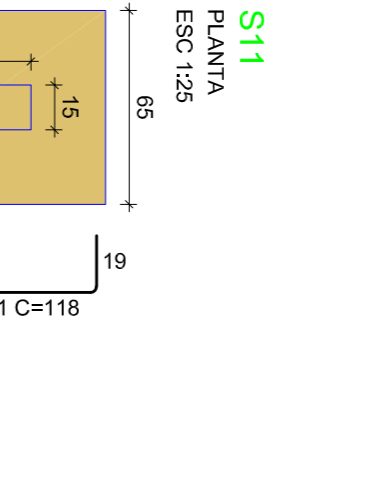
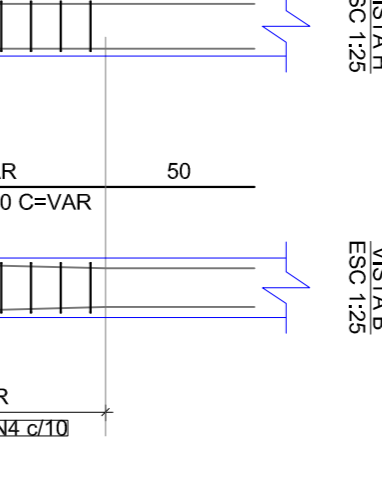
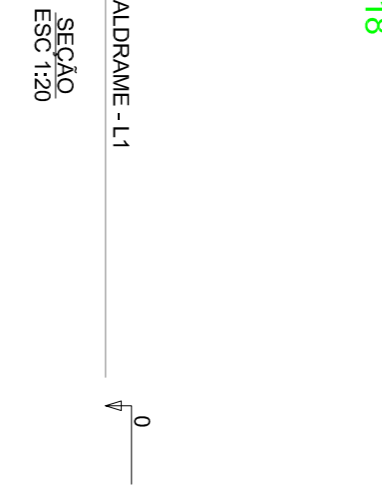

P2=P4=P14

P3

P12

P12

P12

P12

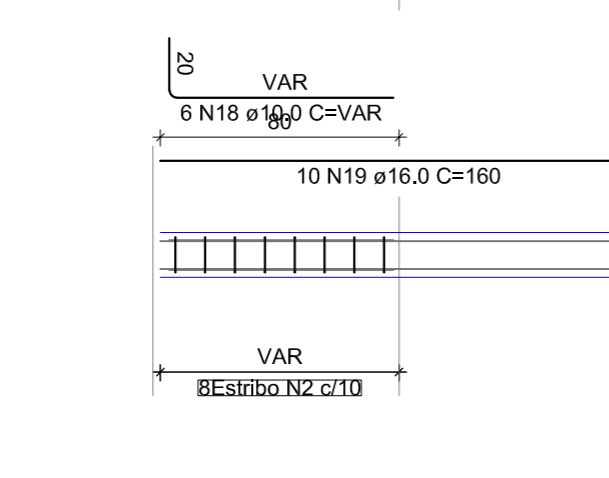
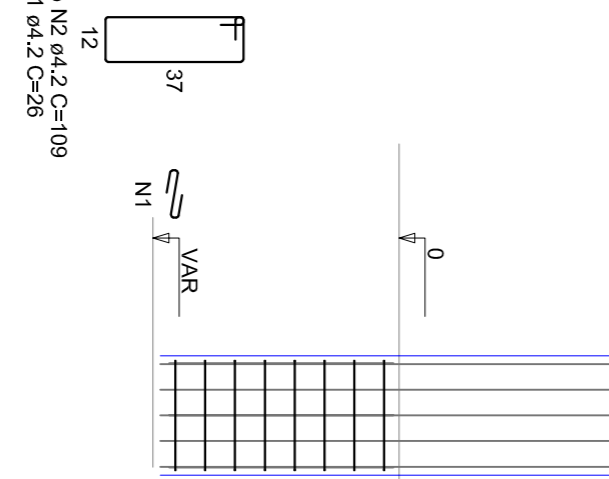
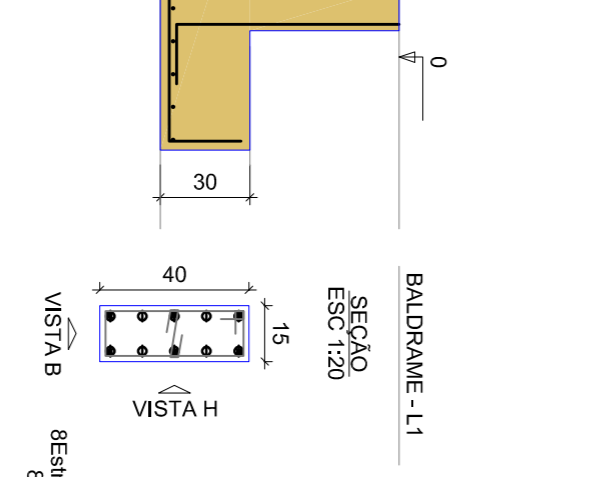
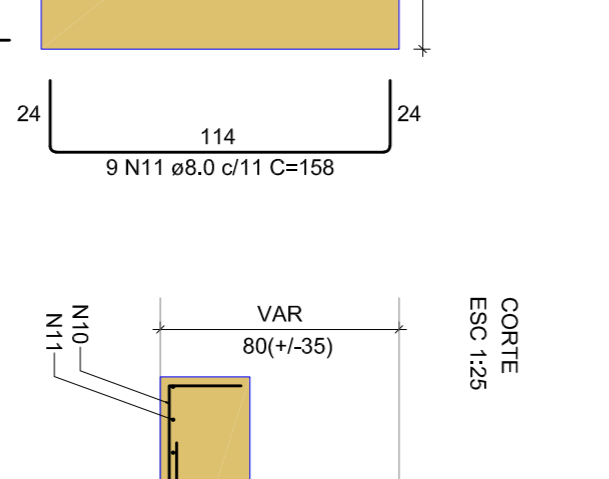
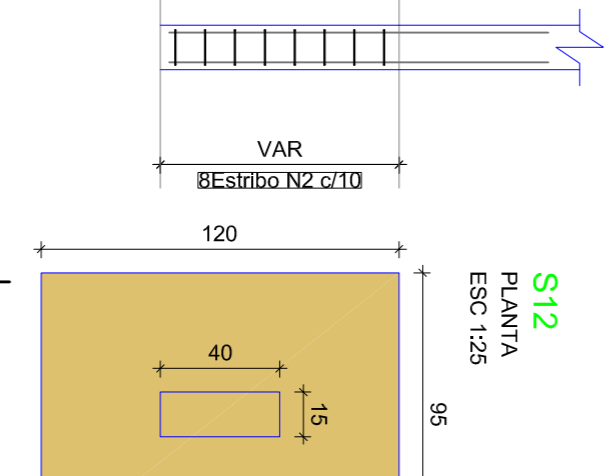
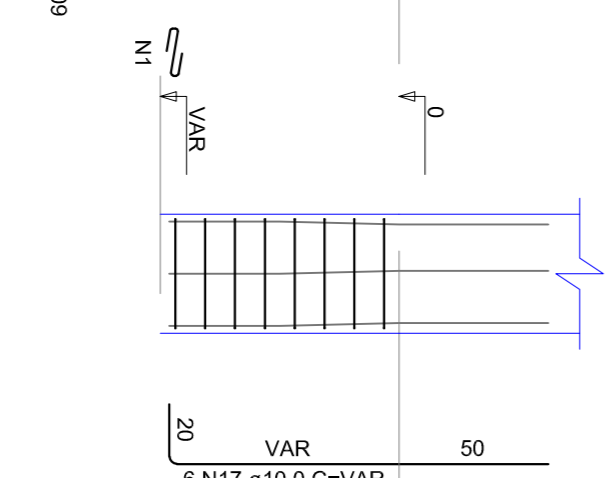
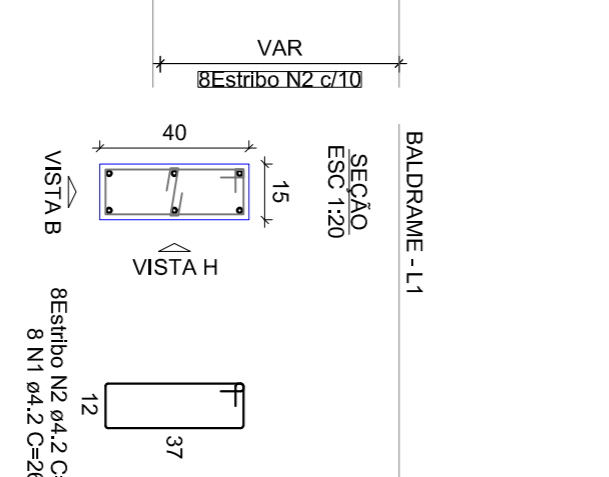
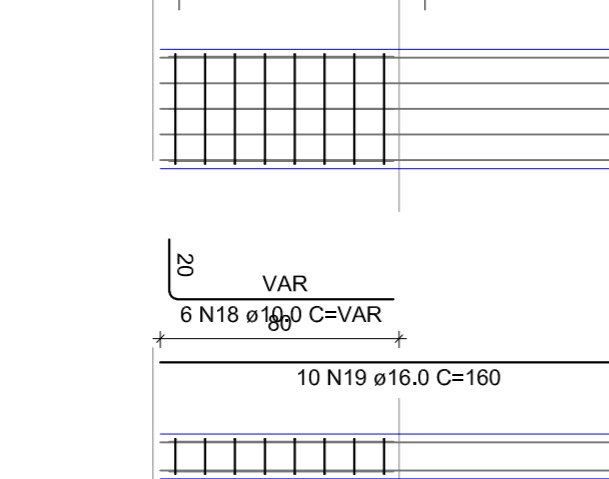
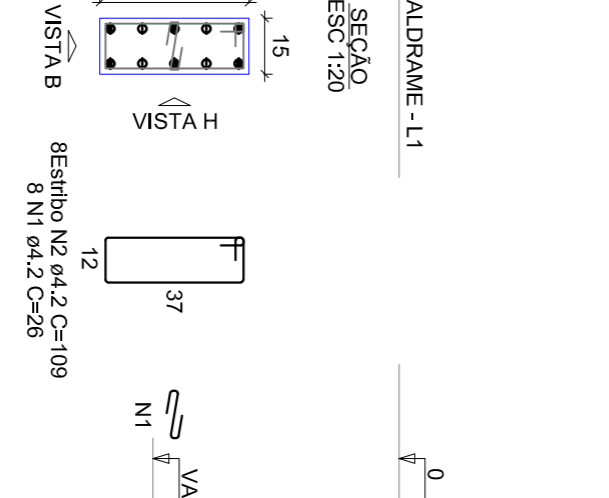

S12 showing a square reinforcement layout with dimensions 120x95 cm and 9 N11 bars. Includes a section view showing 9 N11 bars at a height of 80 cm.

ACO	DIAM (mm)	C.TOTAL (m)	QUANT (Barras)	PESO + 10% (kg)
CA60	16,0	244,2	23	72,8
CA60	16,0	64	6	111,1
CA60	4,2	186,2	18	22,3
PESO TOTAL				
CA60	334,5			
CA60	22,3			

Volume de concreto (C-20) = 0,59 m³
 Volume de escombros (C-20) = 3,48 m³
 Área de forma = 27,37 m²

AMPLIACAO ESPACO EDUCATIVO URBANO - TIO HUGOIRS

RUA CUIABA, BARRIO PROGRESSO - TIO HUGOIRS

PROJETISTA: JEAN BERARDI MANICA
 ENGENHEIRO CIVIL OAB/RS 153340

PROJETO: FERRAGEM DAS SAPATAS

DATA: JULHO/2023

PRONOME: E02

AREA AMPLIACAO: 144,78m²
 AREA TOTAL: 988,76 m²

ESCALA: 1/50